

RoHS

This products can apply to the HHB Doc NO. QA-3-04-005 of Environmental&Material Management Rules

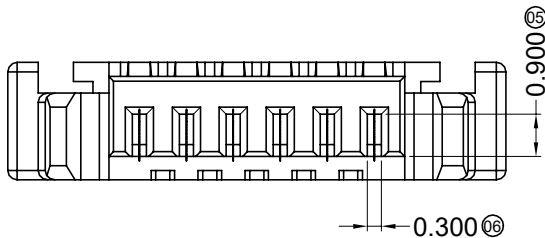
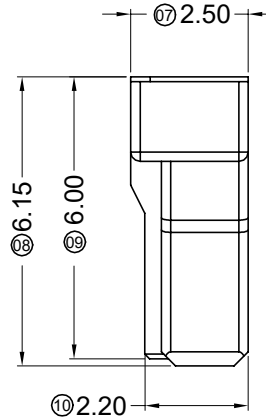
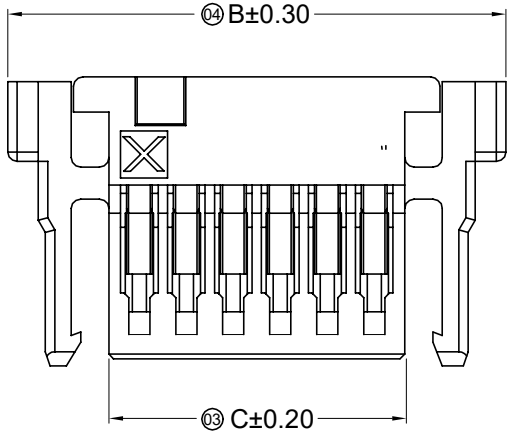
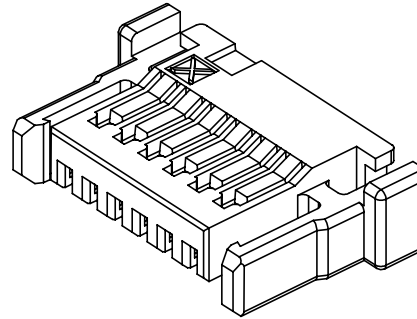
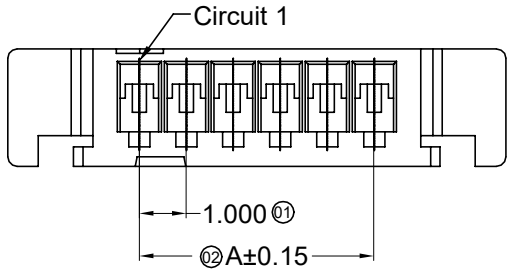

■ Specifications :

- Voltage rating: 125V AC / DC
- Current rating: 1A AC / DC
- Withstanding voltage: 500V AC/minute
- Temperature range: -25°C~+85°C
- Insulation resistance: ≥100MΩ
- Contact resistance: ≤20mΩ
- After environmental testing: ≤40mΩ
- Suitable HHB Terminal: J1005T
- Mates HHB Wafer: J1005W-XX

Poles	Dimensions(mm)			Poles	Dimensions(mm)		
	A	B	C		A	B	C
02	1.00	6.60	2.30	12	11.00	16.60	12.30
03	2.00	7.60	3.30	13	12.00	17.60	13.30
04	3.00	8.60	4.30	14	13.00	18.60	14.30
05	4.00	9.60	5.30	15	14.00	19.60	15.30
06	5.00	10.60	6.30	16	15.00	20.60	16.30
07	6.00	11.60	7.30	17	16.00	21.60	17.30
08	7.00	12.60	8.30	18	17.00	22.60	18.30
09	8.00	13.60	9.30	19	18.00	23.60	19.30
10	9.00	14.60	10.30	20	19.00	24.60	20.30
11	10.00	15.60	11.30				

2020/03/10	B	EN20200314001	Update Drawing Frame	Wzbin	Robing	<b>东莞市翰皓精密电子有限公司</b> DONGGUAN HANHAO PRECISION ELECTRONIC CO.,LTD PROJECT:	PART NO. J1005H-XX			
2014/03/24	C		Space of a Whole page Changes	Jova Lau	Bob Sun		TITLE: 1.00 mm Crimp Style Connectors			
2014/02/07	B		Space of a Whole page Changes	Sylvia	Bob Sun		APPROVAL	CHECK	DRAWN	DATE
DATE	REV	ECN NO	DESCRIPTION	MODIFY	APPROVAL		Bob Sun	Jova Lau	Allen	2013/08/31
						UNIT: mm				
						SCALE: 1:1				
						SHEET: 1/1				
						REV: A				
						NUMBER: A-022				

RoHS

This products can apply to the HHB Doc NO. QA-3-04-005 of Environmental&Material Management Rules

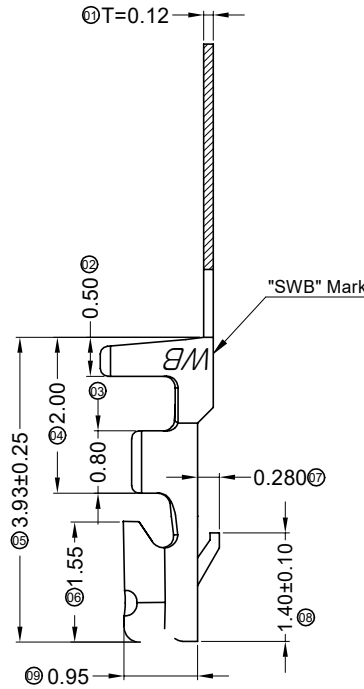
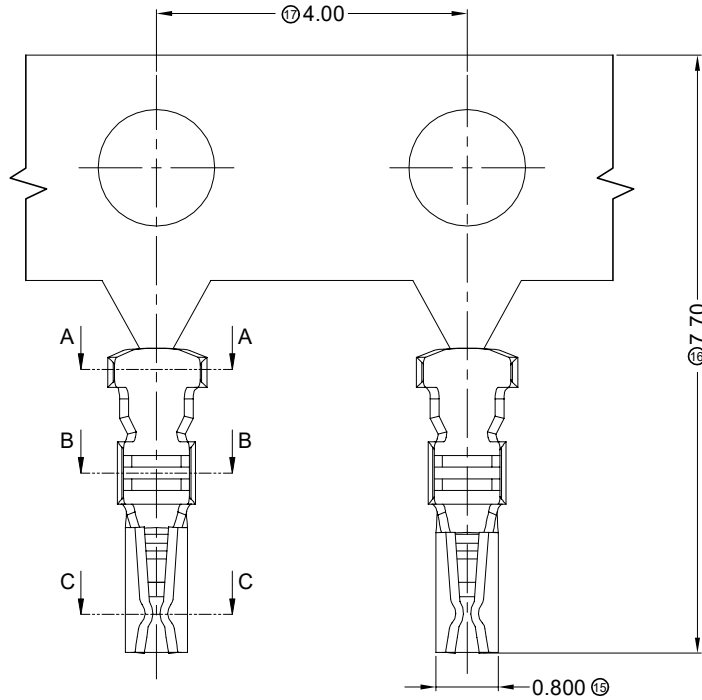

■ Specifications :

- Voltage rating: 125V AC / DC
- Current rating: 1A AC / DC
- Withstanding voltage: 500V AC/minute
- Temperature range: -25°C~+85°C
- Insulation resistance: ≥100MΩ
- Contact resistance: ≤20mΩ
- After environmental testing: ≤40mΩ
- Wire Range: AWG#28-32
- Insulation O.D.: 0.80mm Max
- Used In HHB Housing: J1005H-XX

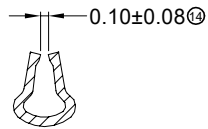

SECTION C-C  
SCALE 1 : 1

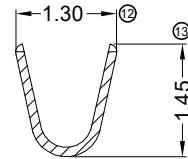

SECTION A-A  
SCALE 1 : 1

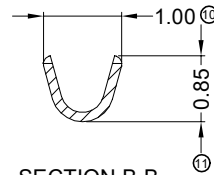

SECTION B-B  
SCALE 1 : 1

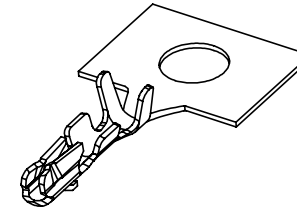

2020/03/14	F	EN20200314001	Update Drawing Frame	Wzbin	Robing	GENERAL TOLERANCE .X ±0.30 .XX ±0.20 .XXX ±0.10 X° ±2° PROJECT 	东莞市翰皓精密电子有限公司 DONGGUAN HANHAO PRECISION ELECTRONIC CO.,LTD				PART NO. J1005T				
2014/03/27	E		Add SWB Mark	sylvia	Bob Sun						APPROVAL				TITLE 1.00 mm Crimp Style Connectors
2014/03/12	D		Space of a Whole page Changes	Jova	Bob Sun		CHECK				UNIT SCALE SHEET REV NUMBER				
DATE	REV	ECN NO	DESCRIPTION	MODIFY	APPROVAL		DRAWN				mm 1:1 1/1 F A-014				

东莞市翰皓精密电子有限公司

DONGGUAN HANHAO PRECISION ELECTRONIC CO.,LTD

PART NO.

J1005T

TITLE

1.00 mm Crimp Style Connectors

UNIT	SCALE	SHEET	REV	NUMBER
mm	1:1	1/1	F	A-014

RoHS

This products can apply to the HHB Doc NO. QA-3-04-005 of Environmental&Material Management Rules

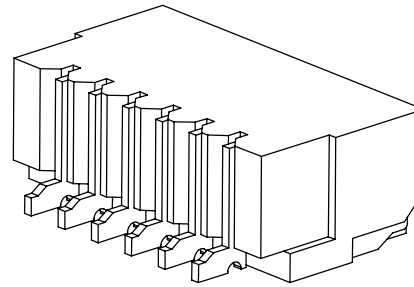
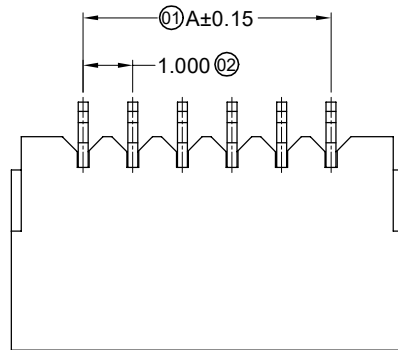

■ Specifications :

- Voltage rating: 125V AC / DC
- Current rating: 1A AC / DC
- Withstanding voltage: 500V AC/minute
- Temperature range: -25°C~+85°C
- Insulation resistance: ≥100MΩ
- Contact resistance: ≤20mΩ
- After environmental testing: ≤40mΩ
- Material(Pin And Solder Tabs):Phosphor Bronze
- Finish(Solder Tabs):Matte Tin Plating
- Mates With HHB Housing :J1005H-XX

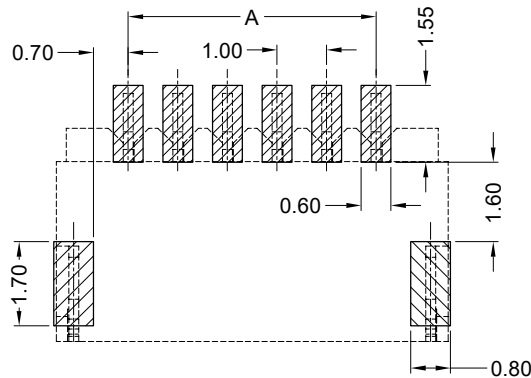
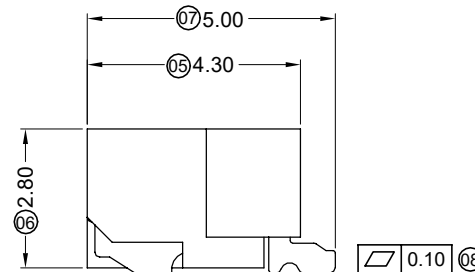
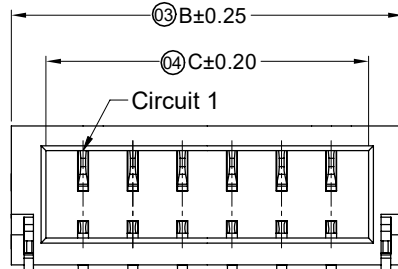

Recommended P.C.B Layout  
General Tolerance±0.05

Poles	Dimensions (mm)			Poles	Dimensions (mm)		
	A	B	C		A	B	C
02	1.00	3.90	2.50	12	11.00	13.90	12.50
03	2.00	4.90	3.50	13	12.00	14.90	13.50
04	3.00	5.90	4.50	14	13.00	15.90	14.50
05	4.00	6.90	5.50	15	14.00	16.90	15.50
06	5.00	7.90	6.50	16	15.00	17.90	16.50
07	6.00	8.90	7.50	17	16.00	18.90	17.50
08	7.00	9.90	8.50	18	17.00	19.90	18.50
09	8.00	10.90	9.50	19	18.00	20.90	19.50
10	9.00	11.90	10.50	20	19.00	21.90	20.50
11	10.00	12.90	11.50				

					GENERAL TOLERANCE				东莞市翰皓精密电子有限公司 DONGGUAN HANHAO PRECISION ELECTRONIC CO.,LTD				PART NO. J1005WRS-XX																	
					.X	±0.30							TITLE																	
A	2020/03/14	C	EN20200314001	Update Drawing Frame	Wzbin	Robing	APPROVAL				CHECK				DRAWN				DATE											
	2014/02/07	B		Space of a Whole page Changes	Sylvia	Bob Sun	.XXX ±0.10				UNIT				SCALE				SHEET				REV				NUMBER			
	DATE	REV	ECN NO	DESCRIPTION	MODIFY	APPROVAL	PROJECT				mm				1:1				1/1				C				A-051			
							X° ±2°				Bob Sun				Jova Lau				Allen				2013/08/31							

RoHS

This products can apply to the HHB Doc NO. QA-3-04-005 of Environmental&Material Management Rules

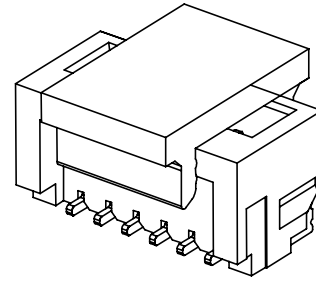
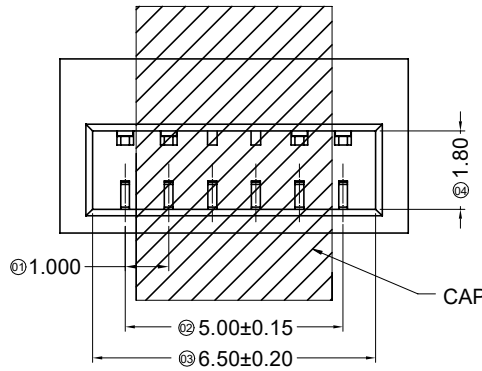

■ Specifications :

- Voltage rating: 125V AC / DC
- Current rating: 1A AC / DC
- Withstanding voltage: 500V AC/minute
- Temperature range: -25°C~+85°C
- Insulation resistance: ≥100MΩ
- Contact resistance: ≤20mΩ
- After environmental testing: ≤40mΩ
- Material(Cap):LCP UL 94V-0
- Material(Pin):Phosphor Bronze
- Material(Solder Tabs):Brass
- Finish(Solder Tabs):Matte Tin plating
- Mates With HHB Housing:J1005H-XX

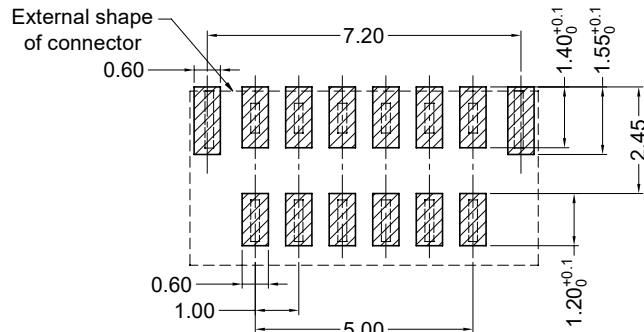
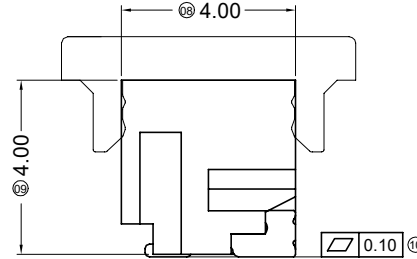
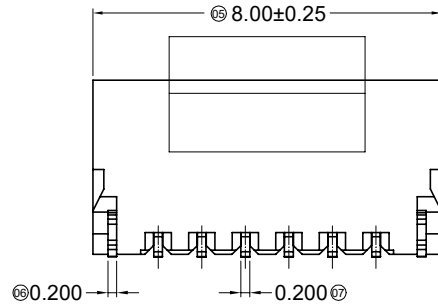

Recommended P.C.B Layout  
General Tolerance±0.05

					GENERAL TOLERANCE					东莞市翰皓精密电子有限公司 DONGGUAN HANHAO PRECISION ELECTRONIC CO.,LTD				PART NO. J1005WVS-XX				
					.X ±0.30									TITLE 1.00mm Crimp Style Connectors				
					.XX ±0.20					APPROVAL		CHECK						
					.XXX ±0.10					Smark		Guo		Wuxiaotao		2016/04/15		
					X° ±2°					PROJECT								
					PROJECT					UNIT		SCALE		SHEET		REV		NUMBER
					PROJECT					mm		1:1		1/1		C		A-000

2020/03/14	C	EN20200314001	Update Drawing Frame	Wzbin	Robing
17.11.30	B	ER20171130001	Add CAP material description	Savvy	Jacky
DATE	REV	ECN NO	DESCRIPTION	MODIFY	APPROVAL